



YOUR
OWN
STYLE
SHOWER
ENCLOSURES

 **inda**[®]
bathroom interiors

INDEX

Your own style.

HISTORY	2
TOTAL LIVING	4
WALK IN	6
INDISSIMA	16
AZURE	28
PRAIA DESIGN	40
CLAIRE DESIGN	52
AIR	66
KLAR	74
TRENDY DESIGN	80
SOPRAVASCA	92

HISTORY

A new way for conceiving the bathroom.

Inda, Gruppo Industriale italiano del settore arredobagno, con i suoi 70 anni d'esperienza è, dal 1944, al servizio di chi desidera arredare il proprio ambiente bagno con stile e funzionalità. La capacità del Gruppo di cogliere le esigenze ed i gusti di un pubblico eterogeneo in continuo cambiamento e di anticipare le tendenze dell'abitare, gli ha permesso di consolidare la leadership nei mercati internazionali. Sono tre le divisioni di prodotto del Gruppo: mobili, pareti doccia ed accessori, le cui creazioni formano in realtà un pensiero unico, ideale per infinite soluzioni d'arredamento della sala da bagno. Creatività, originalità, distintiva eleganza sono elementi caratterizzanti che si esprimono nel design Inda attraverso tutte le sue forme, dal classico, al moderno alle soluzioni più all'avanguardia, che rispondono armoniosamente all'evoluzione dell'abitare. Un progetto globale che si declina in ogni situazione architettonica, grazie all'eccezionale versatilità e dedizione delle proprie risorse creative e produttive.

Inda est un groupe industriel italien spécialisé dans l'aménagement des salles de bains avec 70 années d'expérience au service de tous ceux qui souhaitent meubler leur salle de bains avec style et fonctionnalité. La capacité du groupe à satisfaire les besoins et les goûts d'un public hétérogène en constante évolution et à anticiper les tendances de la décoration d'intérieur lui ont permis de consolider le leadership sur les marchés internationaux. Ce groupe est divisé en trois catégories de produits: meubles, parois de douches et accessoires. Ses créations uniques offrent des solutions de décoration pour salles de bains infinies. La créativité, l'originalité, l'élégance qui le distingue sont des caractéristiques qui se reflètent dans la conception d'Inda sous toutes les formes: du classique au moderne, aux solutions d'avant-garde qui s'adaptent harmonieusement à l'évolution des foyers. Un projet global qui se décline dans toutes les situations architectoniques grâce à la versatilité exceptionnelle et au dévouement des propres ressources créatives et productives.

Since 1944, with over 70 years of experience, Inda - Italian producer of bathroom furniture, accessories and shower enclosures - has been helping its customer to stylish and ergonomically furnish their bathrooms. The Group's ability to capture the needs and tastes of a diverse, constantly-changing public and anticipate current trends has helped it consolidate its leading place in international markets. The Group has three product ranges: furniture, shower enclosures and accessories. Its creations shape a unifying design, ideal for endless bathroom-furnishing solutions. Inda's design arises from creativity, originality and distinctive elegance expressing on all styles from classic to modern, to the most avant-garde solutions, that respond harmoniously to the way living evolves. It is a global project that comes through in every architectural situation thanks to the exceptional versatility and dedication of its creative and productive resources.





TOTAL LIVING

A bathroom with a coordinated aesthetics.

Il bagno, oggi più che mai, è diventato uno spazio imprescindibile del nostro ambiente domestico, passando da un luogo di servizio a una vera e propria esperienza totalizzante. Per questo motivo, Inda propone diverse soluzioni di abbinamento estetico riguardante diverse categorie di prodotto, per arredare il tuo bagno con un'estetica coordinata. Pareti doccia, mobili, accessori: tutto è perfettamente abbinato.

La salle de bains est désormais un espace indispensable dans nos foyers. C'est bien plus qu'une simple pièce de service, c'est une véritable expérience complète de notre quotidien. C'est pour cette raison qu'Inda propose diverses combinaisons d'ordre esthétique dans plusieurs catégories de produits pour meubler votre salle de bains de manière esthétique et coordonnée. Les parois de douche, le meubles et les accessoires sont parfaitement coordonnés.

Today more than ever, bathrooms have become an essential space in our home environment, going from being somewhere to freshen up to a real all-encompassing experience. This is why Inda offers different matching aesthetic solutions for different product categories to furnish your bathroom with a coordinated look. Shower enclosures, furniture, accessories: everything fits perfectly together.





WALK IN

Free space.

Walk In: un programma completo dove libertà compositiva e varietà estetica suggeriscono una nuova libertà di interpretazione per soluzioni complete che esplorano stili di vita differenti. Lastre di cristallo e staffe di rinforzo cromate si uniscono in un sistema che interpreta la parete doccia come uno spazio libero da porte, di immediato accesso e fruizione.

Walk In: un programme complet où la liberté de composition et la variété d'exposition suggèrent une nouvelle liberté d'interprétation pour des solutions complètes qui explorent différent style de vie. Plaques de verre et bras de renfort chromés s'unissent à un système qui interprète la paroi de douche libre de toute porte, accès immédiat.

Walk In: a complete program where composing freedom and esthetic variety suggest a new interpreting freedom for complete solutions that explore different lifestyles. Crystal slabs and chrome reinforcing brackets are joined in a system that interprets the shower wall like a free space free of doors, for immediate access and easy use.











10_WALK IN

Kit di installazione pavimento/soffitto
Kit pour installation sol/plafond
Installation kit floor/roof





WALK_IN_11



12_WALK IN



Pareti
Parois
Panels

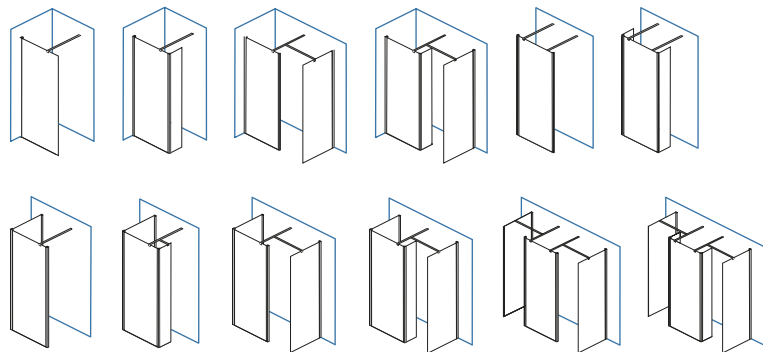

H200

8mm



Pareti
Parois
Panels

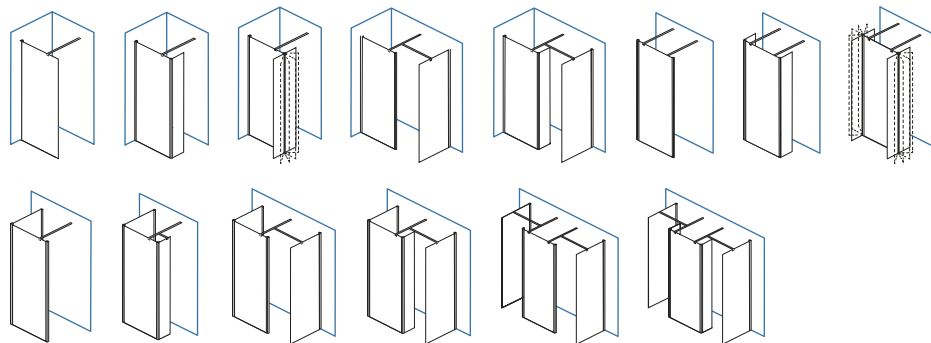

H200

6mm



Telaio
Profilé
Frame



AN
Tipo cromato anodizzato naturale lucido
Type chromé anodisé naturel brillant
Natural polished anodized chrome type



AC
Nickel spazzolato
Nickel brossé
Brushed nickel



WM
Bianco opaco
Blanc mat
White mat



BM
Nero opaco
Noir mat
Black mat

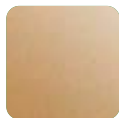

OR
Oro rosato lucido
Doré rosé brillant
Glossy rose-coloured gilded



BZ
Bronzo
Bronze
Bronzed

Vetro
Verre
Glass



01
Trasparente
Transparent
Transparent



14
Grigio
Gris
Grey



73
Trasparente con fascia serigrafata
Transparent avec bande sérigraphiée
Transparent with silk screen printed band

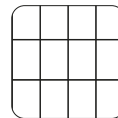

DG
Verrière

Qualità del prodotto
Qualité du produit
Product quality



Inda Glass Protection

Trattamento per la protezione anticalcare del vetro, su richiesta.
Traitement pour la protection du verre, sur demande.
Anti limescale glass protection treatment, on request.

INDISSIMA

Shower enclosures.

Indissima capovolge il paradigma stesso di chiusura doccia. Struttura portante inferiore, che sostiene il concetto estremo di telaio minimale. La più sottile linea telaio presente sul mercato, da luce al volume rigoroso ed elegante di una parete doccia che arreda lo spazio.

Indissima renverse le paradigme même de la fermeture de douche. Structure de support inférieure, qui soutient le concept extrême de cadre minimal. La ligne de cadre la plus fine du marché, mets en lumière le volume rigoureux et l'élégance d'une paroi de douche qui donne de l'espace.

Indissima overturns the very paradigm of shower closure. Lower supporting structure, which supports the extreme concept of minimal frame. The thinnest frame line on the market, bring to light the rigorous and elegant volume of a shower enclosure that furnishes the space.



















Angolare
Accès d'angle
Corner

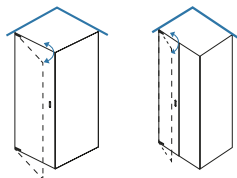

H200

8mm

6mm



Nicchia
Niche
Niche

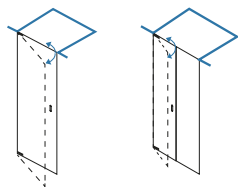

H200

8mm

6mm



Telaio
Profilé
Frame



NS
Acciaio inox spazzolato
Acier inoxydable brossé
Brushed stainless steel

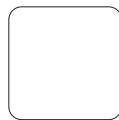

WM
Bianco opaco
Blanc mat
White mat



BM
Nero opaco
Noir mat
Black mat

Vetro
Verre
Glass



01
Trasparente
Transparent
Transparent



14
Grigio
Gris
Grey



Maniglia di serie, foro rettangolare su lastra.
Poignée standard, trou rectangulaire sur plaque.
Standard handle, rectangular hole on plate.



Maniglia opzionale.
Poignée en option.
Optional handle.

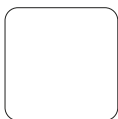

WM
Bianco opaco
Blanc mat
White mat



NS
Acciaio inox spazzolato
Acier inoxydable brossé
Brushed stainless steel



BM
Nero opaco
Noir mat
Black mat



Inda Glass Protection
Trattamento per la protezione anticalcare del vetro, su richiesta.
Traitement pour la protection du verre, sur demande.
Anti limescale glass protection treatment, on request.



Hinge
Cerniere agli estremi lastra incollate con tecnologia UV.
Charnières aux extrémités du verre liées par la technologie UV.
Hinges at the ends of the slab bonded with UV technology.



Hinge
Cerniere agli estremi filo esterno telaio ad apertura esterna ed interna.
Charnières sur le bord extérieur du cadre avec ouverture externe et interne.
Hinges on the outer edge of the frame with external and internal opening.



Frame
Telaio inox inferiore portante in linea con struttura accessori. Carter interno copri viti.
Cadre inférieure en acier inoxydable, aligné avec la structure des accessoires. Couvercle interne pour vis.
Lower supporting stainless steel frame in line with accessory structure. Internal cover for screws.



Frame
Telaio inox superiore minimale in linea con struttura mobili. Telaio inox superiore estremizzato (solo 15 mm).
Cadre supérieur en acier inoxydable minimal aligné avec la structure mobile. Cadre supérieur en acier inoxydable (15 mm seulement).
Minimal upper stainless steel frame in line with mobile structure. Extremely stainless steel upper frame (only 15 mm).

AZURE

The new dimension of shower space.

Tecnica ed estetica raggiungono un nuovo equilibrio, Azure la nuova dimensione dello spazio doccia Inda. Gamma di porte battenti Frameless da 8mm personalizzabili secondo le diverse proposte di maniglie e cerniere, in estetica coordinata con mobili e accessori Inda. Cerniere incollate mediante tecnica UV, filo interno vetro, nuova barra di sostegno, due tipologie di fissaggio a muro, il tutto per una doccia cucita a misura di cliente.

Technique et esthétique atteignent un nouvel équilibre, Azure la nouvelle dimension de l'espace douche Inda. Gamme de portes battantes 8mm Frameless personnalisées selon différentes propositions pour les poignées et les charnières, ayant un esthétisme coordonné avec les meubles et les accessoires Inda. Charnières encollage par la technique UV, au ras du verre intérieure, nouveau bras de renfort, deux types de fixation au mur, le tout pour une douche cousue sur mesure pour le client.

Technical and aesthetic reach a new equilibrium thanks to Azure, the new dimension of Inda shower space. A rich range of frameless pivot doors, with glass thickness 8mm and possible customization according to different proposals for handles and hinges, in a perfect coordination with furniture and accessories by Inda. Hinges glued by UV technique, inner glass wire, new support bar, two wall fixing techniques: everything is thought for a shower perfectly "tailored" to the customer.















Angolare
Accès d'angle
Corner

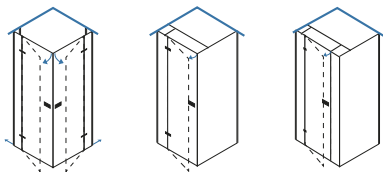

H200

8mm



Nicchia
Niche
Niche

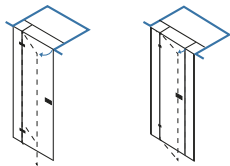

H200

8mm



Telaio
Profilé
Frame



AN

Tipo cromato anodizzato naturale lucido
Type chromé anodisé naturel brillant
Natural polished anodized chrome type

Vetro
Verre
Glass



01

Trasparente
Transparent
Transparent



14

Grigio
Gris
Grey

Maniglia
Poignée
Handle



Cromata. Maniglia di serie.
Chromé. Poignée standard.
Chrome-plated. Standard handle.



Cromata. Maniglia opzionale.
Chromé. Poignée en option.
Chrome-plated. Optional handle.



Vetro/specchio. Maniglia opzionale.
Verre/miroir. Poignée en option.
Glass/mirror. Optional handle.

Qualità del prodotto
Qualité du produit
Product quality



Hinge

Cromata. Le cerniere garantiscono un movimento agevolato di apertura e chiusura delle ante.

Chromé. Ouverture totale des portes aussi bien à l'intérieur que à l'extérieur.

Polished. Hinges guaranteed a smooth door opening and closing movement.



Vetro/specchio. Cerniera opzionale.

Verre/miroir. Charnière en option.

Glass/mirror. Optional hinge.



Magnetic closure

Assicura la massima tenuta all'acqua.

Assure une excellente étanchéité.

It ensures the maximum water resistance.



Reinforcement brackets

Incluse nell'imballaggio. Le staffe sono necessarie per la stabilità degli elementi fissi.

Inclus dans l'emballage. L'utilisation des bras de renfort est nécessaire pour la fixation murale des éléments fixes.

Included in the package. The brackets are necessary for the stability of the fixed elements.



Specchi
Miroir
Mirror



S300
Mirror



S301
Fumé



S302
Bronze

Colori vetro
Verre couleurs
Glass colours



TP521 E
Nero



TP523 E
Grafite



TP520 E
Creta



TP534 E
Avana

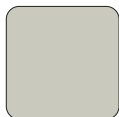

TP519 E
Cemento

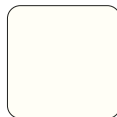

TP500 E
Bianco



TP503 E
Terra di luna



TP532 E
Bruno

HPL



TP182
Calacatta



TP176
Malta



TP177
Porfido



TP179
Pietra chiara



TP78
Pietra scura



TP175
Cemento scuro



TP181
Texas



TP180
Lava



TP174
Yard



TP183
Oregon

PRAIA DESIGN

Great harmony.

Le pareti doccia rappresentano per Inda un elemento significativo legato ai nuovi modi dell'abitare. Un tema che Inda ha interpretato attraverso una matrice progettuale che ha saputo mediare design e tecnologia, ricerca e funzionalità.

Praia Design: nata per ambienti bagno pensati come veri e propri spazi di vita dove ritrovare armonia, benessere e qualità rispecchiando abitudini contemporanee.

La paroi de douche représente pour Inda un élément significatif lié aux nouveaux modes de l'habitat. Un thème que Inda a développé à travers une matrice de projection qui a su mélanger design et technologie, recherche et fonctionnalité. Praia Design: née pour des salles de bains pensées comme de vrais espaces de vie, où retrouver harmonie, bien-être et qualité représentant habitudes contemporaines.

For Inda, the shower enclosure represents an important element connected with modern day living habits. A theme that Inda has developed through a program that has been able to combine design and technology, research and functionality. Praia design: born for bathroom environments thought as functional spaces in which find harmony, wellness and quality, reflecting contemporary habits.













Installazione a muro con telaio o cerniera,
a seconda del vostro gusto estetico.
Un'ampia gamma di configurazioni
enfattizzate dalla doppia valenza stilistica.
Installation murale avec cadre ou
charnière, selon votre goût esthétique. Une
large gamme de configurations soulignée
par la double valeur stylistique.
Wall installation with frame or hinge,
according to your aesthetic taste. A wide
range of configurations underlined by the
double stylistic value.

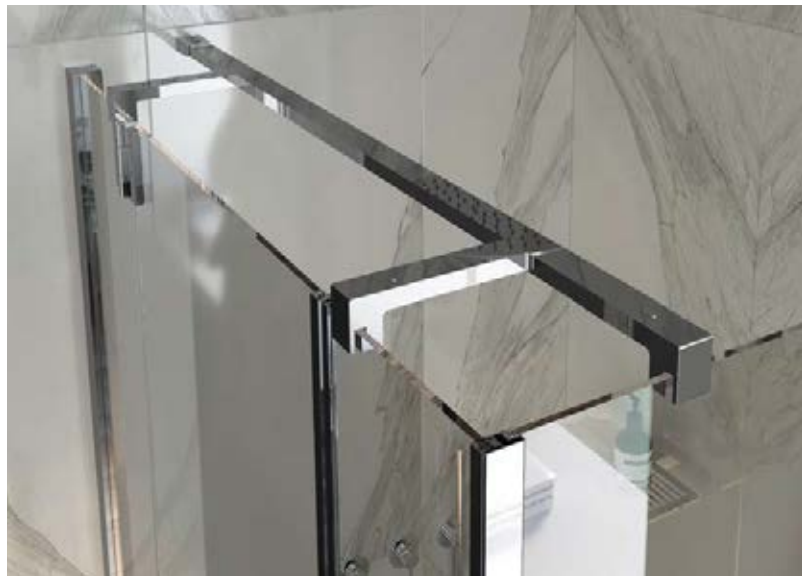









Angolare
Accès d'angle
Corner

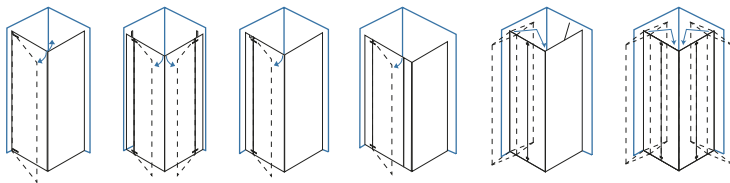

H195

6mm



Nicchia
Niche
Niche

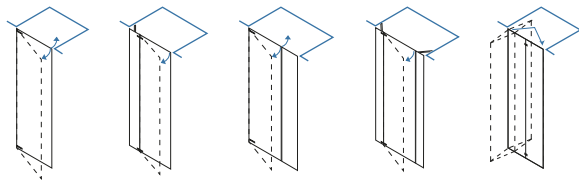

H195

6mm



Telaio
Profilé
Frame



AN

Tipo cromato anodizzato naturale lucido
Type chromé anodisé naturel brillant
Natural polished anodized chrome type



AC

Nickel spazzolato
Nickel brossé
Brushed nickel



WM

Bianco opaco
Blanc mat
White mat



BM

Nero opaco
Noir mat
Black mat

Vetro
Verre
Glass



O1

Trasparente
Transparent
Transparent



14

Grigio
Gris
Grey



80

Ice

Maniglia
Poignée
Handle



Finitura maniglia in abbinamento alla finitura telaio.
Finition de la poignée en combinaison avec la finition du cadre.
Finish of the handle in combination with the finish of the frame.

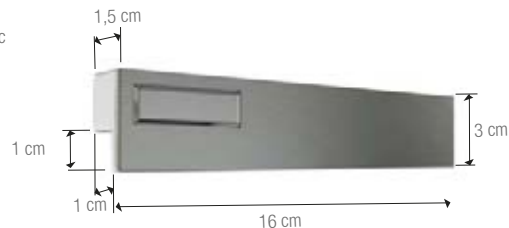

Qualità del prodotto
Qualité du produit
Product quality



Inda Glass Protection

Trattamento per la protezione anticalcare del vetro, su richiesta.
Traitement pour la protection du verre, sur demande.
Anti limescale glass protection treatment, on request.



Wallmounting

Con profili in alluminio estensibili.
Avec profilés en aluminium extensibles.
With extensible aluminium profiles.

(2,5 cm)



Magnetic closure

Assicura la massima tenuta all'acqua.
Adoptée pour tous les articles, assure la maximale étanchéité.
Included in all articles, ensures maximum water resistance.



Wall-glass hinge and glass-glass hinge

Finitura cromata, apertura dell'anta di 180°
Finition chromée, ouverture de la porte à 180°.
Chromed-plated brass, door opening 180°.

CLAIRE DESIGN

Elegance and personality.

I dettagli, le finiture di qualità e l'incredibile luminosità delle pareti doccia Claire Design conferiscono una immediata sensazione di eleganza e personalità all'ambiente bagno. Progettata con massima funzionalità e adattabilità, la serie offre infinite soluzioni compositive tutte con porta a battente per garantire comfort, armonia e raffinatezza.

Les détails, les finitions de qualité et l'incroyable luminosité des parois de douche Claire Design confèrent une immédiate sensation d'élégance et personnalité à la salle de bains. Étudiée pour une fonctionnalité et une adaptabilité totale, la série offre beaucoup de solutions toutes avec des portes battantes pour garantir confort, harmonie et élégance.

Details, qualitative finishes and the incredible brightness of Claire Design shower enclosures confer an immediate elegance and personality sensation to the bathroom. Designed for the highest functionality and adaptability, this product range offers infinite pivot door layout solutions, to ensure comfort, balance and sophistication.















58_CLAIRE DESIGN











62_CLAIRE DESIGN





Angolare
Accès d'angle
Corner

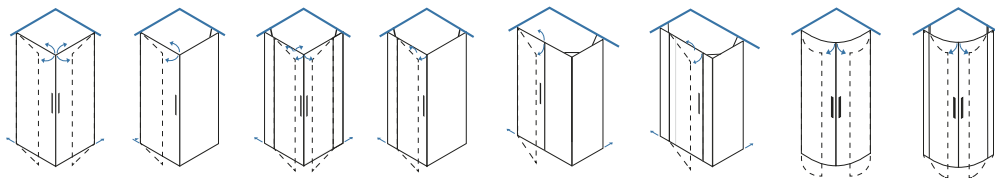

H195

6mm



Nicchia
Niche
Niche

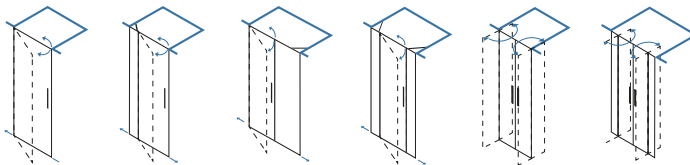

H195

6mm



Telaio
Profilé
Frame



TT
Tipo titanio anodizzato naturale lucido
Type titanium anodisé naturel brillant
Natural polished anodised titanium type



AC
Nickel spazzolato
Nickel brossé
Brushed nickel



BM
Nero opaco
Noir mat
Black mat

Vetro
Verre
Glass



01
Trasparente
Transparent
Transparent



57
Serigrafato
Sérigraphie
Silk screen printed

Maniglia
Poignée
Handle



Finitura maniglia in abbinamento alla
finitura telaio.
Finition de la poignée en combinaison avec
la finition du cadre.
Finish of the handle in combination with
the finish of the frame.

Qualità del prodotto
Qualité du produit
Product quality



Inda Glass Protection

Trattamento per la protezione anticalcare
del vetro, su richiesta.
Traitement pour la protection du verre, sur
demande.

Anti limescale glass protection treatment,
on request.



Upper glass thread

Installazione in vetro in linea con il telaio
per garantire un'estetica lineare.
Installation de verre conformément à
l'encadrement pour une esthétique
linéaire.

Glass installation in line with the frame to
ensure a linear aesthetics.



Extensibility

Estensibilità 2 cm.
Extensibilité 2 cm.
Extensibility 2 cm.



Seal

Il Sistema Cam solleva l'anta per facilitare
il contatto con il bordo del piatto doccia,
evitando la fuori uscita dell'acqua.

Le joint inférieur couplé au système
d'articulation à Came pour le soulèvement
du panneau facilite le contact avec le
bord du receveur de douche évitant les
fuites d'eau.

The Cam system lifts the door facilitating
contact with the edge of the shower tray
for a water tight seal.

AIR

Impeccable design.

Le pareti doccia: sempre più belle e curate, sempre più presenti nelle case, in ambienti bagno che sono diventati veri e propri spazi di vita. A questi, Inda dedica tutte le attenzioni ed un'importante forza produttiva. Il risultato è una gamma di soluzioni in cui si sposano la leggerezza formale e il design impeccabile uniti alla tipologia dei binari e all'altezza di 200 cm per i vetri.

Les parois de douche: toujours plus belles et soignées, toujours plus présentes dans les habitations, dans des salles de bains qui sont devenues de véritables espaces de vie. À cela, Inda dédie toutes les attentions et une importante force productive. Le résultat est une gamme de solutions qui allie la légèreté de la forme au design impeccable uni au rail et à la hauteur 200 cm pour les verres.

The shower enclosures: better looking and smarter, an increasing presence in the home, in the bathroom which has become a focal living area. To these, Inda focuses all its attention and considerable productive force.

The result is a range of solutions where formal lightness and impeccable design get married, combined with the type of binaries and a glass height of 200 cm.











Angolare
Accès d'angle
Corner

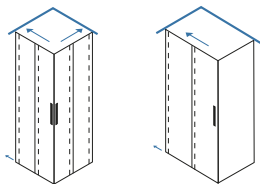

H200

8mm



Nicchia
Niche
Niche

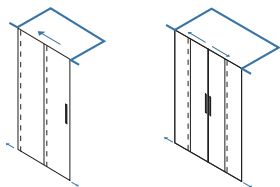

H200

8mm



Telaio
Profilé
Frame



AN

Tipo cromato anodizzato naturale lucido
Type chromé anodisé naturel brillant
Natural polished anodized chrome type

Vetro
Verre
Glass



01

Trasparente
Transparent
Transparent



14

Grigio
Gris
Grey

Maniglia
Poignée
Handle



Cromata.
Chromé.
Chrome-plated.



Qualità del prodotto
Qualité du produit
Product quality



Inda Glass Protection

Trattamento per la protezione anticalcare del vetro, su richiesta.
Traitement pour la protection du verre, sur demande.
Anti limescale glass protection treatment, on request.



Detachable doors

Un semplice gesto per facilitare la pulizia delle ante.
Un simple geste pour faciliter le nettoyage des portes.
A simple operation to facilitate cleaning.



Soft closing

I componenti e i sistemi Soft Close rendono possibile un'apertura e una chiusura dolci e silenziose delle porte scorrevoli, grazie ad un meccanismo completamente invisibile.

Les composants et les systèmes Soft Close rendent possible une ouverture et une fermeture douces et silencieuses des panneaux coulissants grâce à un mécanisme totalement invisible.

Soft Close components and systems make it possible to open and close sliding doors gently and silently, thanks to a completely invisible mechanism.



Internal glass support

Caratteristica per cui tutta la componentistica di supporto alle lastre in cristallo, è compresa nello spessore del vetro. Le cabine doccia con questa proprietà sono particolarmente facili da pulire, in quanto la superficie interna del vetro non subisce alterazioni di spessore. Caractéristique qui consiste à contenir tout le système de fixation du panneau en verre dans son épaisseur. Les parois de douche bénéficiant de cette particularité sont très faciles à nettoyer car la surface interne du panneau en verre ne présente aucune irrégularité d'épaisseur.

This support is within the thickness of the glass itself. Shower stalls with this feature are particularly easy to clean, as the internal surface of the glass is not subject to changes in thickness.

KLAR

Fashionable shapes.

Inda presenta Nuova KLAR. Le tendenze del mercato trovano oggi espressione in un progetto completamente nuovo, caratterizzato da design e styling distintivo, forme decisamente squadrate e spigolose, dimensioni molto ampie, altezza cm. 200, particolari curati nel dettaglio; le soluzioni realizzate sono dedicate ad un pubblico molto esigente ed allo stesso tempo aperto ai cambiamenti e alle novità.

Inda présente la nouvelle Klar. Les tendances du marché trouvent leur expression dans un projet complètement nouveau caractérisé par un design et style bien distinct, formes carrées, dimensions très amples, hauteur 200 cm, détails soignés; les solutions réalisées sont dédiées à un public très exigeant mais ouvert au changement et aux nouveautés.

New Klar slows down your time! Inda presents new Klar. Market tendencies are expressed today by a brand new project, characterized by design and defined styling, squared and sharp shapes, very large dimensions, 200 cm height, very refined details; these solutions are dedicated to a public that is very demanding and at the same time open to change and news.







Angolare
Accès d'angle
Corner

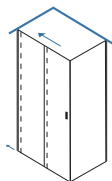

H200

8mm

6mm



Nicchia
Niche
Niche

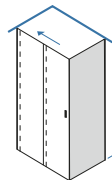

H200

8mm



Telaio
Profilé
Frame



AN

Tipo cromato anodizzato naturale lucido
Type chromé anodisé naturel brillant
Natural polished anodized chrome type



BM

Nero opaco
Noir mat
Black mat

Vetro
Verre
Glass



01

Trasparente
Transparent
Transparent



90

Specchio
Miroir
Mirror





Finitura maniglia in abbinamento alla
finitura telaio.
Finition de la poignée en combinaison
avec la finition du cadre.
Finish of the handle in combination with
the finish of the frame.



Cromata. Maniglia opzionale.
Chromé. Poignée en option.
Chrome-plated. Optional handle.



Vetro temprato trasparente con supporti
inox lucidi. Incollo UV. Maniglia opzionale.
Verre trempé transparent avec supports
en acier inoxydable poli. Collage UV. Poignée
en option.
Clear tempered glass with polished
stainless steel brackets. UV bonding.
Optional handle.



Soft closing

I componenti e il sistema "Soft closing" consentono di aprire e chiudere le porte scorrevoli dolcemente e silenziosamente, grazie ad un meccanismo completamente invisibile.

Les composants et les systèmes Soft Close rendent possible une ouverture et une fermeture douces et silencieuses des panneaux coulissants grâce à un mécanisme totalement invisible. Soft Close components and systems make it possible to open and close sliding doors gently and silently, thanks to a completely invisible mechanism.



Internal glass support

Caratteristica per cui tutta la componentistica di supporto alle lastre in cristallo, è compresa nello spessore del vetro. Le cabine doccia con questa proprietà sono particolarmente facili da pulire, in quanto la superficie interna del vetro non subisce alterazioni di spessore. Caractéristique qui consiste à contenir tout le système de fixation du panneau en verre dans son épaisseur. Les parois de douche bénéficiant de cette particularité sont très faciles à nettoyer car la surface interne du panneau en verre ne présente aucune irrégularité d'épaisseur.

This support is within the thickness of the glass itself. Shower stalls with this feature are particularly easy to clean, as the internal surface of the glass is not subject to changes in thickness.



Detachable doors

Un semplice gesto per facilitare la pulizia delle ante.

Un simple geste pour faciliter le nettoyage des portes.

A simple operation to facilitate cleaning.

TRENDY DESIGN

A new style for your bathroom.

Trendy Design: una serie nel segno della continua ricerca estetica, esplorando gli stili e le ispirazioni più diverse. Porte scorrevoli curate nei dettagli e con un'eccezionale varietà di finiture vetri, interpretano soluzioni perfettamente calate nell'attualità che vanno verso una sempre maggiore individualità.

Trendy Design: une collection sous le signe de la recherche esthétique continue, explore les styles les plus variés. Portes coulissantes aux détails soignés et une variété exceptionnelle de finitions de verre interprètent des solutions parfaitement adaptées à l'actualité qui vont vers une plus grande individualité.

Trendy Design: a series in the sign of continuous esthetic research, exploring the many different styles and inspirations. Sliding doors with attention to detail and exceptional variety of glasses finishes interpreting perfect solution decreased in the actuality which go to always in greater individuality.















86_TRENDY DESIGN





Angolare
Accès d'angle
Corner

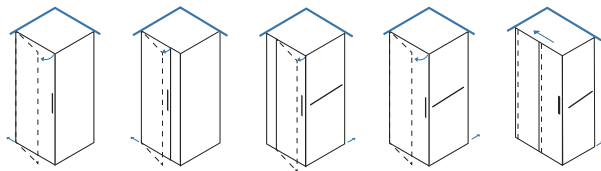

H195

6mm

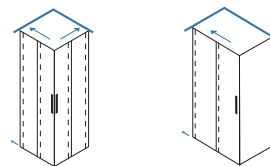

H195

6mm



Nicchia
Niche
Niche

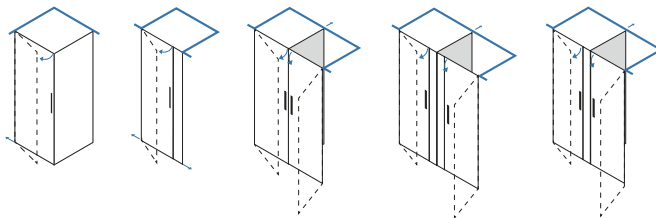

H195

6mm

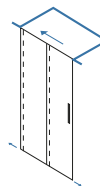

H195

6mm



Telaio
Profilé
Frame



AN
Tipo cromato anodizzato naturale lucido
Type chromé anodisé naturel brillant
Natural polished anodized chrome type



AC
Nickel spazzolato
Nickel brossé
Brushed nickel



WM
Bianco opaco
Blanc mat
White mat



BM
Nero opaco
Noir mat
Black mat

Vetro
Verre
Glass



01
Trasparente
Transparent
Transparent



14
Grigio
Gris
Grey



80
Ice



51
Righe



90
Specchio
Miroir
Mirror



Finitura maniglia in abbinamento
alla finitura telaio. Maniglia di serie.
Finition de la poignée en combinaison
avec la finition du cadre. Poignée standard.
Finish of the handle in combination with
the finish of the frame. Standard handle.



Cromata. Maniglia opzionale.
Chromé. Poignée en option.
Chrome-plated. Optional handle.



CR
Cromato
Chromé
Chrome-plated



DM
Cromato e legno tinto moro
Chromé et bois teinté foncé
Chrome-plated and dark oak



CP
Cromato e plexiglass
Chromé et plexiglas
Chrome-plated and plexiglass

Maniglia opzionale.
Poignée en option.
Optional handle.

Qualità del prodotto
Qualité du produit
Product quality



Inda Glass Protection

Trattamento per la protezione anticalcare del vetro, su richiesta.
Traitement pour la protection du verre, sur demande.
Anti limescale glass protection treatment, on request.



Chrome seal

Profilo con taglio a 45° e chiusura magnetica delle ante.
Profilés avec coupe à 45° et fermeture magnétique des portes.
Profiles with 45° cut and doors with magnetic closure.



Detachable doors

Una semplice azione per facilitare la pulizia.
Un simple geste pour faciliter le nettoyage des portes.
A simple operation to facilitate cleaning.

SOPRAVASCA

Nati con l'obiettivo di trovare nuove soluzioni e nuove opportunità di utilizzo per l'ambiente bagno, i sopravasca completano la gamma delle pareti doccia di Inda. Eleganti pannelli in vetro innovativi ripiegabili a muro e fissi, permettono di fare una doccia quando si è di fretta e consentono di preparare un rilassante bagno quando si necessita di calma e tranquillità.

Nés avec l'objectif de trouver de nouvelles solutions et de nouvelles opportunités pour la salle de bains, les écrans de baignoire complètent la gamme des parois de douche Inda. Élégants panneaux en verre innovants, repliables sur le mur et fixes permettant de prendre une douche quand on est pressé et permettent également de prendre un bain relaxant quand on a besoin de calme et de tranquillité.

Born with the objective to find new solutions and new opportunities of using for bathrooms environment, bathscreens complete the shower wall range of Inda. Elegant and innovative glass panels folding and fixed to wall that allow to take a shower when you are hurry and permit to prepare a relaxed bath when you need calm and peace of mind.





E. CAYUGA (TR.)



94_SOPRAVASCA



SOPRAVASCA_95









Sopravasca
Écrans de baignoire
Bathscreens

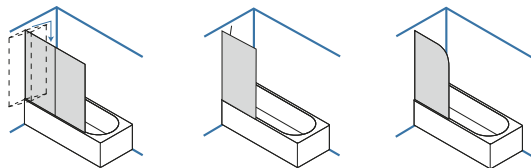

H140

6mm

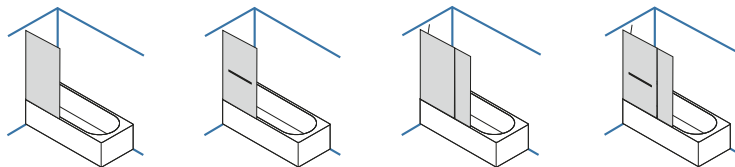

H140

6mm

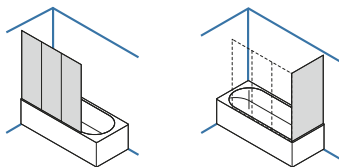

H135

3mm



Telaio
Profilé
Frame



AN
Tipo cromato anodizzato naturale lucido
Type chromé anodisé naturel brillant
Natural polished anodized chrome type



BM
Nero opaco
Noir mat
Black mat



WZ
Bianco verniciato RAL 9010
Blanc verni RAL 9010
White painted RAL 9010



AA
Silver anodizzato naturale opaco
Silver anodisé naturel mat
Natural matt anodized silver

Vetro
Verre
Glass



01
Trasparente
Transparent
Transparent



51
Righe



80
Ice

Qualità del prodotto
Qualité du produit
Product quality



Inda Glass Protection

Trattamento per la protezione anticalcare del vetro, su richiesta.
Traitement pour la protection du verre, sur demande.
Anti limescale glass protection treatment, on request.



180° Panel rotation

La rotazione verso l'esterno dei pannelli semplifica la pulizia.
La rotation des panneaux aussi vers l'extérieur facilite les opérations de nettoyage.
The outward rotation of the panels simplifies cleaning.



Garanzia
Garantie
Warranty



Anta sganciabile
Porte décrochable
Detachable door



Spessore del vetro
Épaisseur verre
Glass thickness



Soft-closing



Altezza
Hauteur
Height



Componenti a filo vetro
Composant à fleur du verre
Component flush with glass



Installazione reversibile
Installation réversible
Reversible installation



Tecnologia incollaggio UV
Technologie de collage UV
UV bonding technology



Installazione non reversibile
Installation non réversible
Not reversible installation



Trattamento anticalcare
Traitement pour la protection du verre
Anti limescale treatment



Inda si riserva, a proprio insindacabile giudizio, di apportare modifiche anche senza preavviso, allo scopo di migliorare la produzione.

Inda reserves the right to modify the products without advance notice to improve production.

Inda se réserve le droit, à tout moment et à son jugement sans appel, d'apporter des modifications sans préavis, afin d'améliorer la production.

INDA SpA

Registered Office
Operational Headquarters
Via dell'Industria, 41
I-24040 Pagazzano (BG)

Bathroom Furniture
Via Postumia Ovest, 72
I-31048 Olmi di San Biagio di Callalta (TV)

www.inda.net
info@inda.net

P.Iva: IT03868760962
Registro Imprese di Bergamo: 03868760962
Numero REA: BG – 386581
Capitale Sociale: Euro 4.000.000,00 i.v.



